

Residential Steam Humidifier

RELIABLE COMFORT FOR THE ENTIRE FAMILY



FIELD CONTROLS

Reliable Comfort for the Entire Family

Compatible with Any Forced Air System

The Field Controls Steam Humidifier is compatible with virtually every make and model of forced air system and it is ideal for use with heat pumps.

Automatic Performance, Any Time

The Field Steam Humidifier operates any time there is a call for humidity, not just when there is a call for heat. This means maximum comfort for the homeowner since humidity can be added at any time through the forced air system.

Reliable, Fresh Humidity

It is also designed for optimum efficiency and reliability thanks to an onboard control system that automatically performs routine maintenance and monitors operation and safety. The automatic flush system drains the humidifier every twenty-four hours of operation. The pan only refills when there is a call for humidity. This is a preventative maintenance mode that keeps the pan clean and the water fresh. The pan will remain empty whenever not in use for more than 24 hours, such as humid periods of summer. This ensures fresh water and prevents stagnation and the problems associated with other types of humidifiers. The S2000 can output up to 16 gallons of water per day and the S2020 can output up to 23 gallons per day.

Information is Power

The S2000 and S2020 steam humidifiers have a built-in computer chip to ensure maximum efficiency, accuracy, reliability and safety. The easy to read LEDs on the unit communicate operation and trouble-shooting information.

Hard Water Problems?

The Z100 anode acts as a sacrificial metal. If your customer has hard water, the minerals in the water will cling to the anode instead of components inside the humidifier.

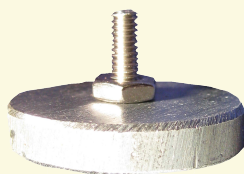

Humidistat Control



Features

- Automatically drains to keep tank clean
- Onboard computer monitors all functions
- Two models - 120 volt and 220 volt
- Interlocking wiring for fan control
- LEDs for system readout
- Replaceable sacrificial anode
- Optional water filter
- Reliable copper heating element

Benefits

- Humidifies whenever needed, without a call for heat
- Compatible with all forced air heating systems
- 100% guaranteed- NO stagnating water
- Water is allowed to cool before draining
- Works with heat pumps and geo-thermal systems
- Reduced clogging thanks to the auto flushing and sacrificial anode

Reliable Comfort for the Entire Family

Comfort & Health

Your home's humidity level is a key component to improved indoor air quality and the overall health and comfort of you and your home. The Environmental Protection Agency (EPA) suggests maintaining proper indoor relative humidity (RH) levels between 40% and 60% to reduce the effects of many unwanted conditions associated with poor indoor air quality.

Too much humidity in your home can cause an increase in mold, bacteria, viruses, fungi, and dust mites. Not enough humidity can be a breeding ground for viruses and bacteria and lead to nosebleeds, painful skin irritation, difficulty breathing and allergic reactions.

Protect Your Home & Valuables

Extreme low and high levels of humidity in your home can cause permanent damage to floors, walls, and furnishings. Valuables in the home such as wood furniture, floors, cabinets, and musical instruments can dry out with too little humidity while extremely high levels of humidity can lead to mold and mildew issues. The Field Controls Steam Humidifier with digital humidistat will provide the precise control you need to keep your home in the optimum humidity range, protecting your family, home, and property.

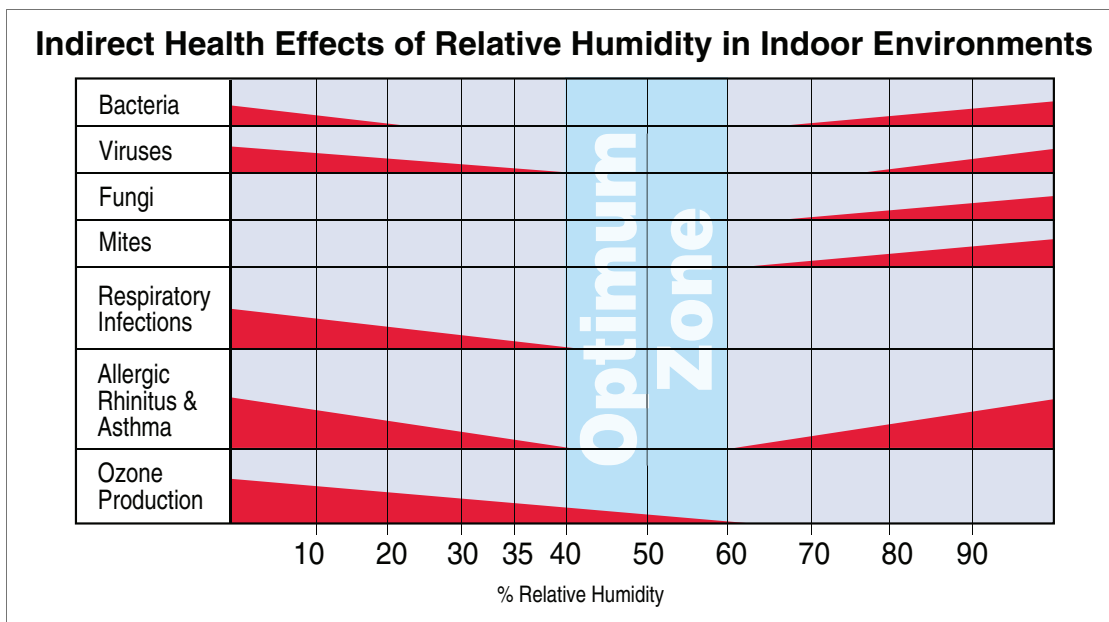

Sizing the humidifier for your home

- Calculate the total cubic feet of your home**
 - * Total home square feet x Average ceiling height
 - Note: Include the basement
- Calculate humidity load requirement in pounds per hour (lbs/hr)**
 - * Total cubic feet of your home x Preferred indoor RH% factor (see table)
 - * Multiply result by 1.05 for each fireplace
- Converting (lbs/hr) to gallons per day (gpd)**
 - * Humidity load (lbs/hr) x 2.88 Factor = Gallons per day (gpd)

Source: Residential Humidity Load Made Easy; Scheurich, Dean, 12/23/09 et al.







Example

- 2,500 sq ft x 8 ft ceiling height = 20,000 cubic ft
- 20,000 cubic ft x 0.00021 (RH% Factor for 45% humidity @ 68°) = 4.2 lbs/hr
- 4.2 lbs/hr x 2.88 = 12.096 (gpd)









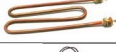

Indoor Air Temp °F	Preferred Indoor RH% Factor			
	35%	40%	45%	50%
68°	0.00015	0.00018	0.00021	0.00024
70°	0.00017	0.00020	0.00023	0.00026
72°	0.00019	0.00022	0.00025	0.00028

* Factors based on 0.5 air changes per hour (ACH)

Accessories

	Part No.	Accessory	Description
	WH-100	Water Hammer Arrestor	Used to eliminate pipe noise.
	APD	Air Proving Device	Proves air flow before engaging heating element. A split core current sensing relay will monitor the on/off status of any blower motor. Insures humidifier only operates when your fan is functioning.
	WC-25	Steam Treatment Cartridge	Water filter cartridge that helps reduce mineral build up. Lasts for one heating season.
	IDB	Internal Duct Bracket	Permanent mounting bracket makes servicing quicker and easier.
	UDB	Under Duct Bracket	Permanent mounting bracket makes servicing quicker and easier.
	46645200	Bimetallic Thermal Cutoff	Electrical safety device that interrupts electric current in case of overload. Opens at a high temperature and re-closes when the temperature drops.
	46100000	ClearWave®	Conditions hard water without the expense and hassle of salt, chemicals, or traditional hard water systems. Attacks hard water particles with electro-magnetic waves, treating the entire water system in your home and helping prevent and reduce hard water problems.

Replacement Parts List

	Model Part No.		Part Description
	S2000	S2020	
	2120	—	120 Volt Heater Assembly
	—	2240	240 Volt Heater Assembly
	2001	2001	24 Volt Solenoid Valve Assembly
	2002	2002	Thermistor Probe Assembly
	2003	2003	Water Level Probe Assembly
	2010	2011	Circuit Board Assembly
	2006	2006	Drain Valve Assembly
	2007	2007	Tank Baffle
	2008	2008	Insulation Kit
	Z100	Anode	Replacement sacrificial anode. Lasts one full season.
	072000	Humidistat Control	Automatic Humidistat adjusts the indoor Relative Humidity (RH)% based on the outdoor temperature. Wall mount or duct mount. Can be used in Automatic or Manual mode for RH setting. Outdoor air sensor included.

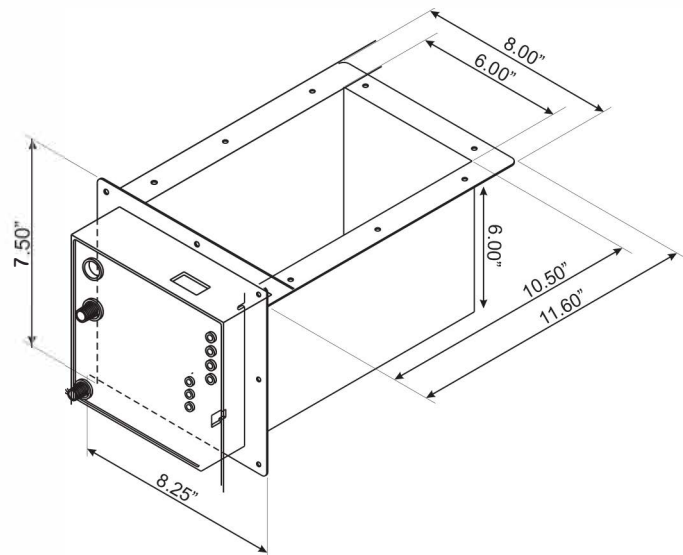

Residential Steam Humidifier Specifications

	Model	Output Capacity (gallons per day)	Voltage	Watts	Amps	Hz	Plenum Opening (Inches)	Weight (Lbs.)	Humidistat Included
	S2000	16	120 VAC	1.4	11.6	—	6 x 6	9	Yes
	S2020	23	220 VAC	2.0	8.5	—	6 x 6	9	Yes



FIELD CONTROLS
fieldcontrols.com